



LEISTUNGSERKLÄRUNG



DoP: 0125

für fischer Highbond-Anker FHB (Verbundanker für die Verwendung in Beton) – DE

1. Eindeutiger Kenncode des Produkttyps: **DoP: 0125**
2. Verwendungszweck(e): **Nachträgliche Befestigung im gerissenen und ungerissenen Beton, siehe Anhang, insbesondere Anhänge B 1 bis B 4**
3. Hersteller: **fischerwerke GmbH & Co. KG, Klaus-Fischer-Straße 1, 72178 Waldachtal, Deutschland**
4. Bevollmächtigter: --
5. System(e) zur Bewertung und Überprüfung der Leistungsbeständigkeit: **1**
6. Europäisches Bewertungsdokument: **ETAG 001; 2013-04**
Europäische Technische Bewertung: **ETA-06/0171; 2017-05-26**
Technische Bewertungsstelle: **DIBt**
Notifizierte Stelle(n): **1343 – MPA Darmstadt**
7. Erklärte Leistung(en):

Mechanische Festigkeit und Standsicherheit (BWR 1), Sicherheit bei der Nutzung (BWR 4)

- **Charakteristischer Widerstand: Siehe Anhang, insbesondere Anhänge C 1 bis C 3**
- **Verschiebungen unter Zug- und Querbeanspruchung: Siehe Anhang, insbesondere Anhang C 3**

Brandschutz (BWR 2)

- **Brandverhalten: Der Dübel erfüllt die Anforderungen der Klasse A 1**
- **Feuerwiderstand: KLF**

8. Angemessene Technische Dokumentation und/oder Spezifische Technische Dokumentation: ---

Die Leistung des vorstehenden Produkts entspricht der erklärten Leistung/den erklärten Leistungen. Für die Erstellung der Leistungserklärung im Einklang mit der Verordnung (EU) Nr. 305/2011 ist allein der obengenannte Hersteller verantwortlich.

Unterzeichnet für den Hersteller und im Namen des Herstellers von:

Andreas Bucher, Dipl.-Ing.

Wolfgang Hengesbach, Dipl.-Ing., Dipl.-Wirtsch.-Ing.

i.V. A. Bucher

i.V. W. Hengesbach

Tumlingen, 2017-06-02

- Diese Leistungserklärung wurde in verschiedenen Sprachversionen erstellt. Für den Fall unterschiedlicher Auslegung hat immer die englische Version Vorrang.
- Der Anhang enthält freiwillige und ergänzende Informationen in englischer Sprache. Diese gehen über die (sprachneutral angegebenen) gesetzlichen Anforderungen hinaus.

Specific Part

1 Technical description of the product

The fischer Highbond-anchor FHB is a torque controlled bonded anchor consisting of a mortar cartridge with FIS HB and an anchor rod with hexagon nut and washer. The anchor rod (including nut and washer) is made of galvanised steel.

The load transfer is realised by mechanical interlock of several cones in the bonding mortar and then via a combination of bonding and friction forces in the anchorage ground (concrete).

The product description is given in Annex A.

2 Specification of the intended use in accordance with the applicable European Assessment Document

The performances given in Section 3 are only valid if the anchor is used in compliance with the specifications and conditions given in Annex B.

The verifications and assessment methods on which this European Technical Assessment is based lead to the assumption of a working life of the anchor of at least 50 years. The indications given on the working life cannot be interpreted as a guarantee given by the producer, but are to be regarded only as a means for choosing the right products in relation to the expected economically reasonable working life of the works.

3 Performance of the product and references to the methods used for its assessment

3.1 Mechanical resistance and stability (BWR 1)

Essential characteristic	Performance
Characteristic resistance	See Annex C 1 to C 3
Displacements under tension and shear loads	See Annex C 3

3.2 Safety in case of fire (BWR 2)

Essential characteristic	Performance
Reaction to fire	Anchorage satisfy requirements for Class A1
Resistance to fire	No performance assessed

3.3 Hygiene, health and the environment (BWR 3)

Regarding dangerous substances there may be requirements (e.g. transposed European legislation and national laws, regulations and administrative provisions) applicable to the products falling within the scope of this European Technical Assessment. In order to meet the provisions of Regulation (EU) No 305/2011, these requirements need also to be complied with, when and where they apply.

3.4 Safety in use (BWR 4)

The essential characteristics regarding Safety in use are included under the Basic Works Requirement Mechanical resistance and stability.

4 Assessment and verification of constancy of performance (AVCP) system applied, with reference to its legal base

In accordance with guideline for European technical approval ETAG 001, April 2013, used as European Assessment Document (EAD) according to Article 66 Paragraph 3 of Regulation (EU) No 305/2011, the applicable European legal act is: [96/582/EC].

The system to be applied is: 1

Installation conditions

Pre-positioned anchor

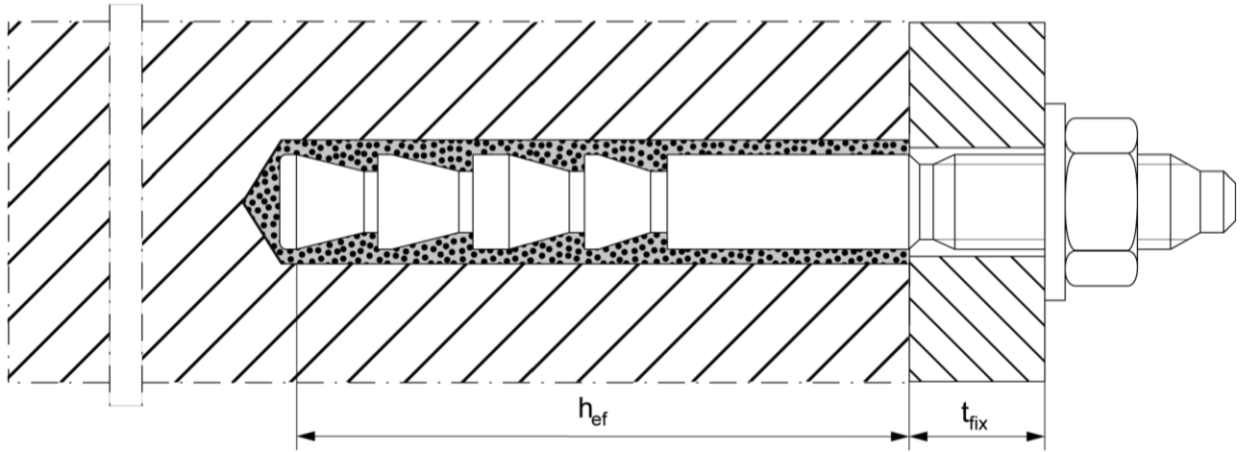

Installation conditions with additional mounted filling disc

Pre-positioned or push through anchor

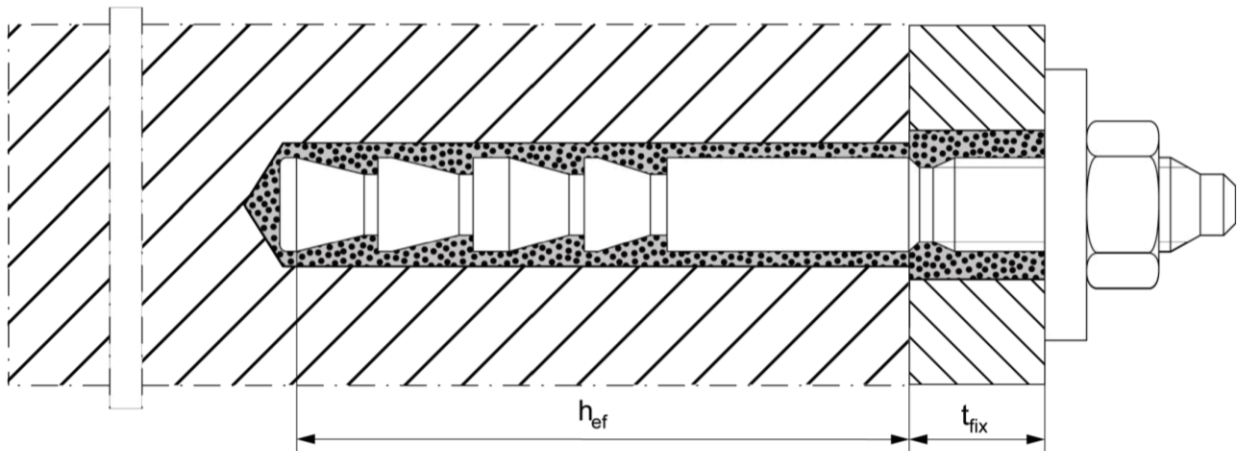

t_{fix} Thickness of the fixture
 h_{ef} Effective anchorage depth

fischer Highbond-Anchor FHB

Product description
 Installation conditions

Annex A 1

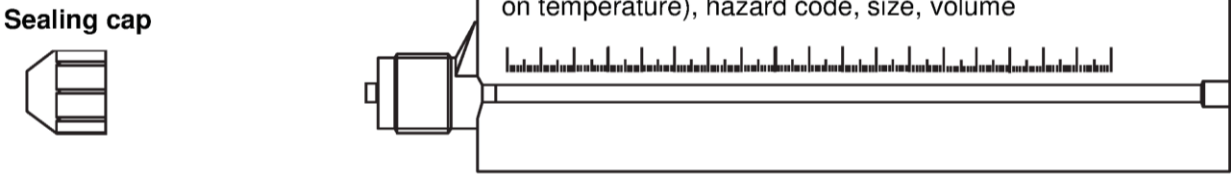
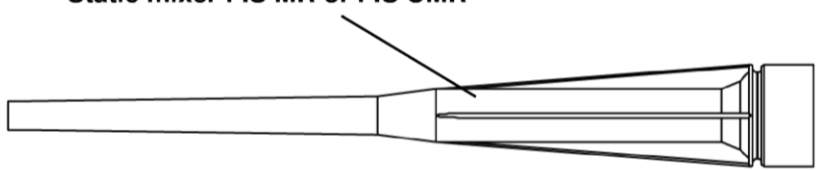
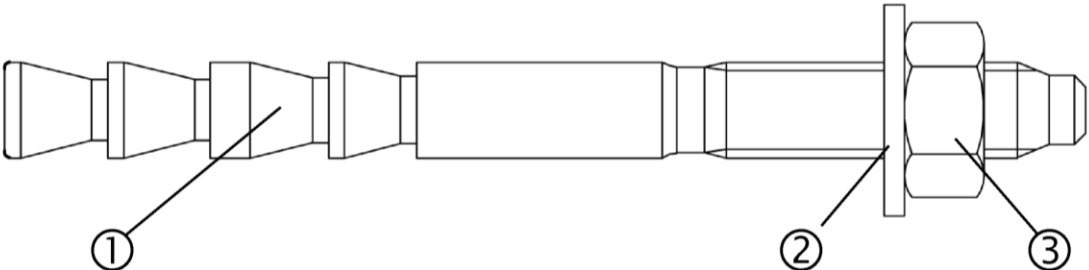
<p>Cartridge sizes FIS HB (345 ml or 150 ml)</p> <p>Imprint: fischer FIS HB, processing notes, shelf-life, piston travel scale, curing times and processing times (depending on temperature), hazard code, size, volume</p>  <p>Sealing cap</p> <p>Static mixer FIS MR or FIS UMR</p>  <p>Highbond-Anchor rod FHB-A</p> 			
Table A1: Materials			
Part	Designation	M10 to M16	M20 to M24
1	Highbond-Anchor rod FHB-A	Steel $f_{uk} = 800 \text{ N/mm}^2$ $f_{yk} = 640 \text{ N/mm}^2$ (ISO 898-1: 2013) zinc plated $\geq 5 \mu\text{m}$, (EN ISO 4042:1999 A2K) $f_{uk} \leq 1000 \text{ N/mm}^2$ $A_5 > 12 \%$ fracture elongation coated	Steel $f_{uk} = 550 \text{ N/mm}^2$ $f_{yk} = 440 \text{ N/mm}^2$ (ISO 898-1: 2013) zinc plated $\geq 5 \mu\text{m}$, (EN ISO 4042:1999 A2K) $f_{uk} \leq 1000 \text{ N/mm}^2$ $A_5 > 12 \%$ fracture elongation coated
2	Washer ISO 7089:2000 or fischer filling disc	zinc plated $\geq 5 \mu\text{m}$, EN ISO 4042:1999 A2K	
3	Hexagon nut	Property class 8;(EN ISO 898-2:2013), zinc plated $\geq 5 \mu\text{m}$,(ISO 4042:1999 A2K)	
fischer Highbond-Anchor FHB			Annex A 2
Product description Cartridge / Static mixer / Anchor rod with hexagon nut and washer Materials			



Specifications of intended use			
Table B1: Overview use and performance categories			
Anchorages subject to		FIS HB with ...	
		fischer Highbond-Anchor rod FHB 	
Hammer drilling with standard drill bit		all sizes	
Hammer drilling with hollow drill bit (Heller "Duster Expert" or Hilti "TE-CD, TE-YD")		all sizes	
Static and quasi static load, in	uncracked concrete	all sizes	Tables: C1, C2, C3, C4
	cracked concrete		
Use category	dry or wet concrete	all sizes	
	flooded hole	all sizes	
Installation temperature		-5 °C to +40 °C	
In-service temperature	Temperature range	-40 °C to +80 °C (max. long term temperature +50 °C and max. short term temperature +80 °C)	
<p>Base materials:</p> <ul style="list-style-type: none"> Reinforced or unreinforced normal weight concrete Strength classes C20/25 to C50/60 according to EN 206-1:2000 <p>Use conditions (Environmental conditions):</p> <ul style="list-style-type: none"> Structures subject to dry internal conditions <p>Design:</p> <ul style="list-style-type: none"> Anchorages have to be designed by a responsible engineer with experience of concrete anchor design Verifiable calculation notes and drawings are prepared taking account of the loads to be anchored. The position of the anchor is indicated on the design drawings (e.g. position of the anchor relative to reinforcement or to supports, etc.) Anchorages under static or quasi-static are designed in accordance with: <ul style="list-style-type: none"> EOTA ETAG 001, Annex C, 08/2010 <p>Installation:</p> <ul style="list-style-type: none"> Anchor installation is to be carried out by appropriately qualified personnel and under the supervision of the person responsible for technical matters of the site In case of aborted hole: The hole shall be filled with mortar Anchorage depth should be marked and adhered to on installation Overhead installation is allowed 			
fischer Highbond- Anchor FHB			Annex B 1
Intended Use Specifications			

Table B2: Installation parameters for fischer Highbond-Anchor rod FHB-A

Size		FHB-A 10x60	FHB-A 12x80	FHB-A 12x100	FHB-A 16x125	FHB-A 20x170	FHB-A 24x220
Width across flat	SW	17	19		24	30	36
Nominal drill bit diameter	d_0	12	14		18	24	28
Drill hole depth	h_0	65	85	105	130	175	225
Embedment depth of anchor	l_d	62	82	102	128	175	225
Effective anchorage depth	h_{ef}	60	80	100	125	170	220
Minimum spacing and minimum edge distance	$s_{min} = c_{min}$	60	80	100	100	150	180
Diameter of clearance hole in the fixture ¹⁾	d_f	12	14		18	22	26
Minimum thickness of concrete member	h_{min}	120	160	200	250	340	440
Maximum installation torque	$T_{inst,max}$ [Nm]	20	40		60	100	120
Designation steel brush		FIS BS 12	FIS BS 14		FIS BS 18	FIS BS 24	FIS BS 28
Corresponding steel brush diameter	d_b [mm]	13	16		20	26	30

¹⁾ For larger clearance holes in the fixture see EOTA ETAG 001, Annex C, 08/2010

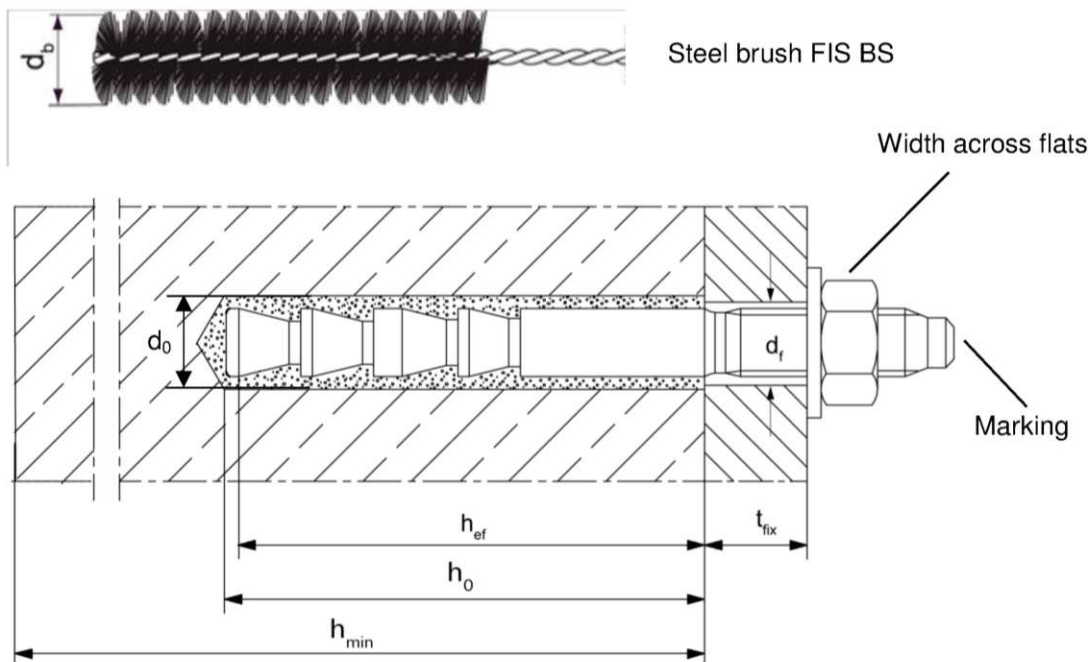

Marking: Work symbol; size, anchorage depth h_{ef} ; e. g. 16 x 125

fischer Highbond- Anchor FHB

Intended Use
Installation parameters Highbond-Anchor rods FHB-A

Annex B 2

Table B3: Maximum processing time of the mortar and minimum curing time

System temperature ¹⁾ [°C]	Maximum processing time $t_{work}^{2)}$	Minimum curing time $t_{cure}^{3)}$
-5 to -1	--	6 h
0 to +4	--	3 h
+5 to +9	15 min	90 min
+10 to +19	6 min	35 min
+20 to +29	4 min	20 min
+30 to +39	2 min	12 min

¹⁾ During the curing of the mortar the temperature of the concrete may not fall below -5°C

²⁾ The temperature of the mortar may not fall below +5°C

³⁾ In wet concrete or flooded holes the curing times must be doubled

Installation instructions (Part 1)

Drilling and cleaning the hole (hammer drilling with standard drill bit)

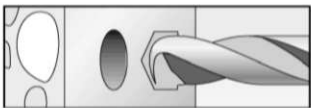
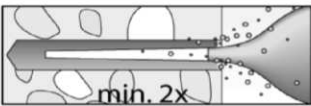
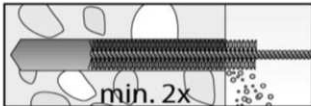
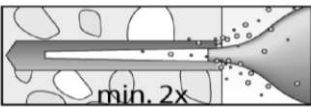
1		Drill the hole with hammer drill. Drill hole diameter d_0 and drill hole depth h_0 see Table B2
2		Blow out the drill hole twice by hand
3		Brush the hole twice. Corresponding steel brushes see Table B2
4		Blow out the drill hole twice by hand

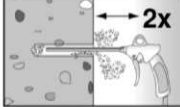
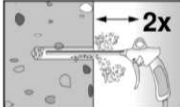

Go to step 5

Drilling and cleaning the hole (hammer drilling with hollow drill bit)

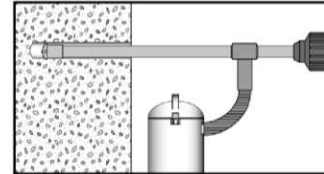
1		Check a suitable hollow drill (see Table B1) for correct operation of the dust extraction
2		Use a suitable dust extraction system, e. g. Bosch GAS 35 M AFC or a comparable dust extraction system with equivalent performance data Drill the hole with hollow drill bit. The dust extraction system has to extract the drill dust nonstop during the drilling process and must be adjusted to maximum power. Diameter of drill hole d_0 and drill hole depth h_0 see Table B2

Go to step 5

fischer Highbond- Anchor FHB	Annex B 3
Intended use Processing times and curing times Installation instructions part 1	





Installation instructions part 2	
Preparing the cartridge	
5	 <p>Remove the sealing cap</p>
6	 <p>Screw on the static mixer (the spiral in the static mixer must be clearly visible)</p>
7	 <p>Place the cartridge into the dispenser</p>
8	 <p>Extrude approximately 10 cm of material until the resin is evenly grey in colour. Do not use mortar that is not uniformly grey</p>
Go to step 9	
Injection the mortar; Installation Highbond-Anchor rod FHB-A	
9	 <p>Adhere to the maximum processing time (t_{work}) of the mortar (see Table B3). Fill approximately 2/3 of the drill hole with mortar. Exact quantity of mortar (travel scale on the cartridge) see instruction sheet. Fill the drill hole with mortar, always begin from the bottom of the hole to avoid bubbles</p>
	 <p>Only use clean and oil-free Highbond- Anchor rod FHB-A. Push the anchor rod down to the bottom of the hole, turning it slightly while doing so</p>
10	 <p>After inserting the anchor rod, excess mortar must be emerged around the anchor rod</p>
	 <p>For overhead installations support the anchor rod with wedges. (e.g. fischer centering wedges)</p> 
11	 <p>Wait for the specified curing time t_{cure} see Table B3</p>
12	 <p>Screw on the fixture and for installation check generate the correct torque moment ($T_{inst,max}$ see Table B2)</p>
Option	 <p>After the minimum curing time is reached, the gap between anchor and fixture and the fischer filling disc may be filled with mortar (for eliminating the gap); compressive strength $\geq 50 \text{ N/mm}^2$ (e.g. FIS HB)</p>
fischer Highbond- Anchor FHB	
Intended use Installation instructions part 2	
Annex B 4	

Table C1: Characteristic values under static or quasi-static tension load for fischer Highbond-Anchor FHB-A								
Size FHB-A		10x60	12x80	12x100	16x125	20x170	24x220	
Bearing capacity under tensile load, steel failure								
Characteristic resistance	$N_{Rk,s}$	[kN]	26	44	44	82	131	180
Partial safety factors¹⁾								
Partial safety factor	$\gamma_{Ms,N}$	[-]	1,50					
Bearing capacity under shear load, steel failure								
without lever arm								
Characteristic resistance	$V_{Rk,s}$	[kN]	16	30	30	55	60	85
with lever arm								
Characteristic bending moment	$M^0_{Rk,s}$	[Nm]	60	105	105	266	357	617
Partial safety factors¹⁾								
Partial safety factor	$\gamma_{Ms,V}$	[-]	1,25					
¹⁾ In absence of other national regulations								
fischer Highbond-Anchor FHB							Annex C 1	
Performance Characteristic steel bearing capacity anchor rods								

Table C2: General design factors for the bearing capacity under tensile / shear load; uncracked or cracked concrete							
Size FHB-A				all sizes			
Bearing capacity under tensile load							
Factors for the compressive strength of concrete > C20/25							
Increasing factor for $N_{Rk,p}$	C30/37	Ψ_c	[-]	1,22			
	C40/50			1,41			
	C50/60			1,55			
Splitting failure							
Edge distance	$C_{cr,sp}$ = $C_{cr,N}$	[mm]	1,5 h_{ef}				
Spacing	$S_{cr,sp}$ = $S_{cr,N}$		3,0 h_{ef}				
Bearing capacity under shear load							
Concrete pry-out failure							
Factor k according to ETAG 001, Annex C, Section 5.2.3.3	k	[-]	2,0				
Concrete edge failure							
The value of h_{ef} (= l_t) under shear load	[mm]	60	80	100	125	170	220
Calculation diameters							
Size FHB-A	d_{nom} [mm]	10x60	12x80	12x100	16x125	20x170	24x220
		10	12	12	16	20	24
fischer Highbond-Anchor FHB						Annex C 2	
Performances General design factors relating to the characteristic bearing capacity under tensile/ shear load							

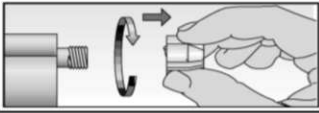
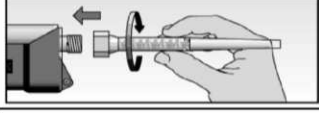
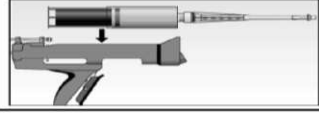
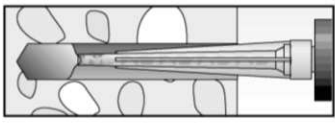
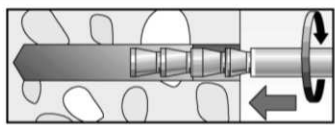
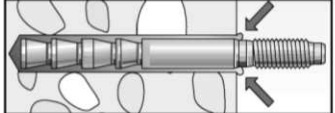
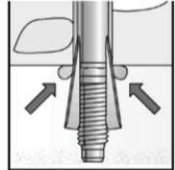
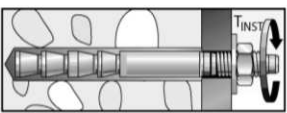
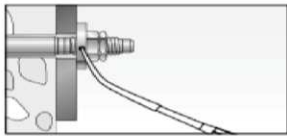
Table C3: Characteristic values of resistance for fischer Highbond-Anchor FHB-A; uncracked or cracked concrete								
Size FHB-A			10x60	12x80	12x100	16x125	20x170	24x220
Combined pullout and concrete cone failure								
Calculation diameter	d	[mm]	10	12	16	20	24	
Uncracked concrete								
Characteristic resistance in uncracked concrete C20/25								
Temperature range 50 °C / 80 °C	$N_{Rk,p}$	[kN]	20	25	35	50	60	115
Cracked concrete								
Characteristic resistance in cracked concrete C20/25								
Temperature range 50 °C / 80 °C	$N_{Rk,p}$	[kN]	1)	1)	30	1)	60	95
Montagesicherheitsfaktor								
All installation conditions	$\gamma_2 = \gamma_{inst}$	[-]	1,0					
1) Pullout not decisive								
Table C4: Displacements for fischer Highbond-Anchor FHB-A								
Size FHB-A			10x60	12x80	12x100	16x125	20x170	24x220
Displacement-Factors for tensile-load								
Uncracked concrete								
Tension load	N	[kN]	9,5	11,9	16,7	23,8	28,6	54,8
Displacements	δ_{N0}	[mm]	0,2	0,2	0,3	0,3	0,5	
	$\delta_{N\infty}$		0,8	0,7	0,7	0,7	1,1	
Cracked concrete								
Tension load	N	[kN]	7,8	12,0	14,3	23,4	28,6	45,2
Displacements	δ_{N0}	[mm]	0,5	0,5	0,6	0,6	0,9	
	$\delta_{N\infty}$		0,8	0,7	0,7	0,7	1,1	
Displacement-Factors for tensile-load								
Uncracked or cracked concrete								
Shear load	V	[kN]	9,3	17,0	31,6	33,9	48,8	
Displacements	δ_{V0}	[mm]	1,3					
	$\delta_{V\infty}$		2,0					
fischer Highbond-Anchor FHB							Annex C 3	
Performances Characteristic values for static or quasi-static action under tensile load (uncracked and cracked concrete); Displacements								